

electriQ

USER MANUAL

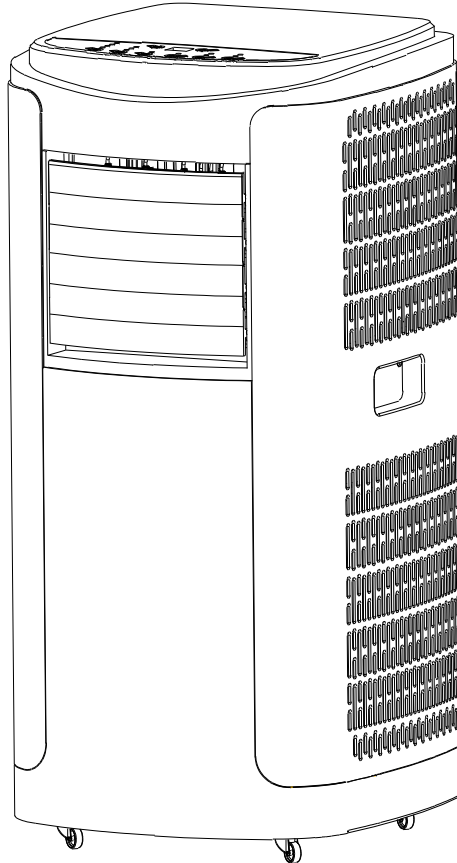

electriQ 12,000 BTU PORTABLE AIR CONDITIONER WITH HEAT PUMP AND WIFI

Thank you for choosing electriQ.

Please read this user manual before using this innovative Air Conditioner and keep it safe for future reference.

Visit our page, www.electriQ.co.uk, for our entire range of Intelligent Electricals.

SETTLING IN OK?

We hope this has been helpful to you.

We would love to see how you're getting on with your new purchase, so please share any snaps you have on the platform of your choice below.

Our community awaits your uploads - Snap, tag and hashtag away!



@electriQUK
#electriQUK

WE'RE HERE TO HELP

Should you have any problems or questions with your purchase, please contact a member of our customer service team.

☎ 0330 390 3061

✉ support@electriQ.co.uk

Mon-Fri | 9am to 5pm

Unit 2A, Trident Business Park,
Neptune Way, Leeds Road,
Huddersfield, HD2 1UA

CONTENTS

SAFETY INFORMATION	4
FEATURES	7
PARTS LIST	7
INSTALLATION	8
OPERATION	10
REMOTE CONTROL	11
EMPTYING THE INTERNAL WATER TANK	12
WIFI APP CONTROL	13
SETTING UP THE APP	14
CONNECTING THE AIR CONDITIONER	15
CONTROLLING YOUR DEVICE	17
SMART SCENES	20
CLEANING AND MAINTENANCE	23
TROUBLESHOOTING	24
ERROR CODES	24
SUPPORT	25
TECHNICAL SPECIFICATION	26

SAFETY INSTRUCTIONS

Important!





- Carefully read the instructions before operating the unit
- This appliance is for indoor use only.
- Rating: This unit must be only connected to a 220-240 V / 50 Hz earthed outlet. The fuse rating can be found on the plug itself.
- Installation must be in accordance with the wiring regulations, gas regulations and any other applicable regulations of the country where the unit is used.
- If you have any doubt about the suitability of your electrical supply, have it checked and, if necessary, modified by a qualified electrician.
- You must follow the venting and set-up instructions; failure to do so will cause damage to the unit, which is not covered under your warranty.
- This air conditioner has been tested and is safe to use. However, as with any electrical appliance - use it with care.
- Do not obstruct any of the ventilation openings.
- The airflow should never be restricted, for example by: venting the unit into a condenser box or reducing the hoses diameter, as this can lead to damage to the unit.
- Disconnect the power from the appliance before dismantling, assembling or cleaning.
- Avoid touching any moving parts of the appliance.
- Never insert fingers, pencils or any other objects through the guard.
- **WARNING:** Do not pierce or burn any part of the unit.
- This appliance is not intended for use by persons (including children) with reduced physical, sensory or mental capabilities. It is also not intended for use by those with a lack of experience and knowledge unless they have been given supervision or instruction concerning the use of the appliance by a person responsible for their safety.
- Do not leave children unsupervised with this appliance.
- Do not clean the unit by spraying it or immersing it in water.
- Never connect the unit to an electrical outlet using an extension cord. If an outlet is not available, one should be installed by a qualified electrician.
- Never operate this appliance if the cord or plug is damaged. Ensure the power cord is not stretched or exposed to sharp objects/edges.
- A damaged supply cord should be replaced by the manufacturer or a qualified electrician to avoid a hazard.
- Any service other than regular cleaning or filter replacement should be performed by an authorised service representative. Failure to comply could result in a voided warranty.
- Do not use the appliance for any purpose other than its intended use.
- **The air conditioner unit must always be stored and transported upright; otherwise, irreparable damage may be caused to the compressor. If there is doubt, we suggest waiting at least 24 hours before starting the unit.**



- Avoid restarting the air conditioning unit unless 3 minutes have passed since being turned off. This prevents damage to the compressor.
- Never use the mains plug as a switch to start and turn off the air conditioning unit. Use the provided ON/OFF button located on the control panel.
- Always place the unit on a dry, stable, flat surface.
- The appliance should not be installed in the laundry or wet rooms.
- The appliance must be placed in a room without sources of ignition (for example, open flames, an operating gas appliance or an operating electric heater).
- R290 refrigerant gas complies with European environmental directives.
- R290 has a low GWP (Global Warming Potential) of 3.
- This air conditioner contains around 280 g of R290 refrigerant gas.
- Do not use or store in an unventilated space with an area smaller than 18.2 m² per unit.
- **WARNING:** The appliance must be stored in a room without continuously operating ignition sources, for example, open flames, an operating gas appliance or electric heaters.
- The room must be such as to prevent stagnation of possible leaks of refrigerant gas as there could be a danger of fire or explosion should the refrigerant come into contact with electric heaters, stoves or other ignition sources.
- Only store and use the unit whilst upright; do not lay it down or tip it.
- Do not place the unit near any ovens or other heat sources. This may be dangerous but will lead to the unit working harder and using more energy.
- Do not place the unit in direct sunlight; this can affect its appearance and cause it to work hard and be less energy efficient.
- Refrigerant gas may be odourless.
- Do not use the product and contact the retailer for advice if damage has occurred to the unit, which may have compromised the refrigerant system.
- Any repairs or maintenance must only be done on the unit by a suitably qualified engineer. Before opening and servicing the unit, the authorised engineer must be in possession of a copy of the manufacturer's service manual and must follow the safety information contained within it to ensure all hazards are minimised.
- The refrigerant system should not be perforated or punctured.
- At the end of the unit's lifetime, always dispose in line with local regulations.
- Ensure all storage conditions in the manual are followed.
- **WARNING:** Do not use means to accelerate the defrosting process or to clean the unit.

ENERGY SAVING AND UNIT SAFETY PROTECTION TIPS

- Do not cover or restrict the airflow from the outlet or inlet grills.
- For maximum performance the minimum distance from a wall or objects should be 50cm.
- Keep the filters clean. Under normal conditions, filters should only need cleaning once every three weeks (approximately). Since the filters remove airborne particles, more frequent cleaning may be necessary, depending on the air quality.
- For the initial start-up, set the fan speed to maximum and the thermostat to 5 degrees lower than the current temperature. After, set the fan switch to low and set the thermostat to your desired setting.
- To protect the unit, we recommend not using the cooling function when the ambient temperature exceeds 35°C. The unit's performance may be affected at lower temperatures than this. If a very hot day is predicted, it is recommended to run the unit overnight in the desired room.

	WARNING: This appliance contains flammable refrigerant. If this leaks and comes into contact with an external ignition source, there is a fire risk.
	CAUTION: The operation manual should be read thoroughly.
	CAUTION: Any service personnel working on the unit should read the service manual prior.
	CAUTION: Information on operation and servicing is in the manual.

FEATURES

- 4 in 1 Cooling, Heating, Fan, Dehumidifier. The P12HPW is great for Rooms up to 30 m².
- 3-speed fan: Balancing quiet operation with performance.
- 24 Hours Start / Stop Timer.
- Digital Thermostat.
- Remote Control.
- Smart WIFI app control
- Auto-Restart to retain the settings in the event of power failure.
- Castors for Enhanced Portability.

PARTS LIST

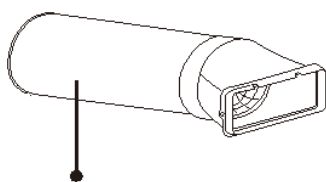
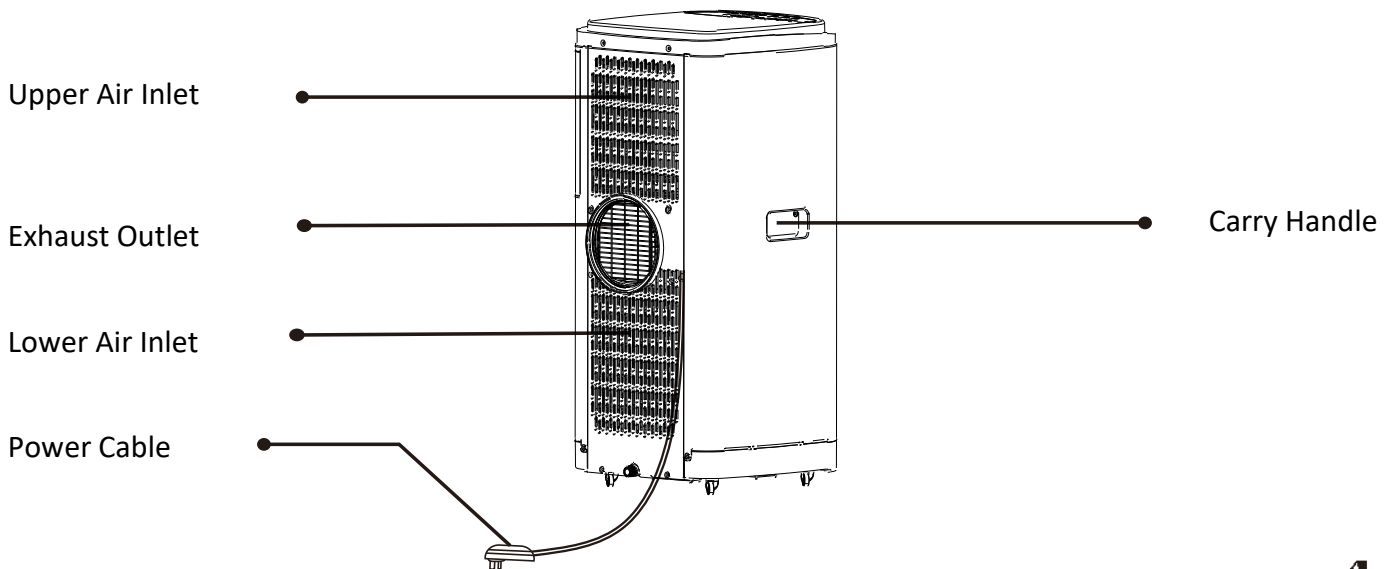
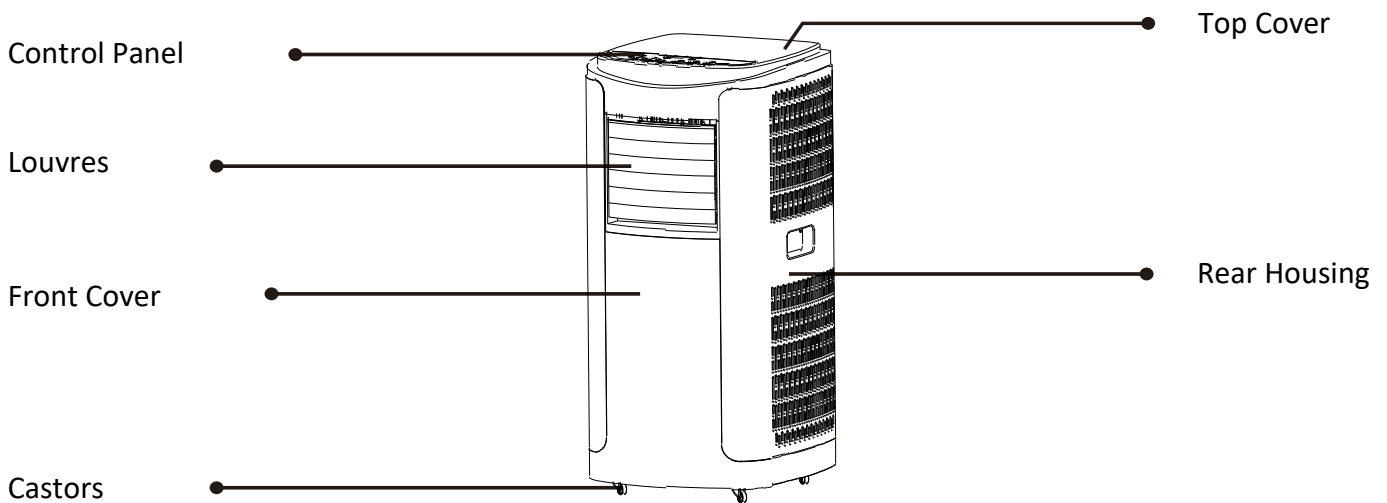

Exhaust Hose



Window Slide Bar

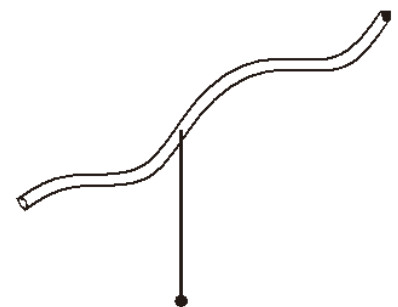

Drainage Pipe

* NOTE: Diagrams of accessories are for illustrative purposes only, actual design may vary.

INSTALLATION

WARNING: Please keep this unit upright for at least 3-4 hours before using it.

This unit can easily be moved from one room to another. While moving the unit, please note that it must always be kept upright and then placed on an even surface.

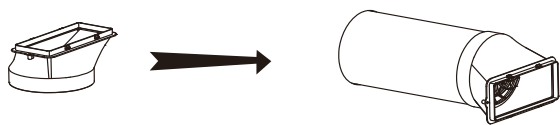

1. Attach the fishtail connector to the end of the hose by extending the end and twisting until firmly attached (At least 3 full rotations).

2. Attach the opposite end of the pipe to the exhaust outlet on the rear of the appliance by putting it into position and twisting until firmly attached (At least 3 full rotations)

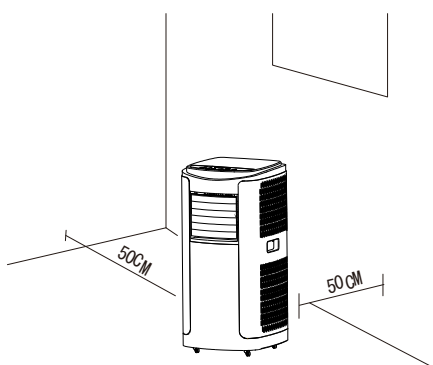
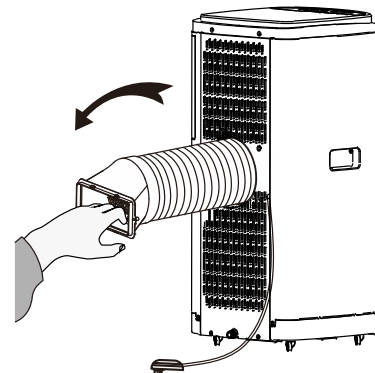

3. Ensure the unit is upright and there are no obstructions to the air inlets and outlet grills.

INSTALLATION OF WINDOW KIT

The window kit (slide bar and fishtail) can be used with sliding windows and doors. The fishtail should be used on its own for other types of windows. You can purchase other types of attachments for different styles of windows. These will aid in keeping the hot air out of your room in summer but are not necessary.

1. Partially open the window and place the extended slide bar in position before closing the window onto it.

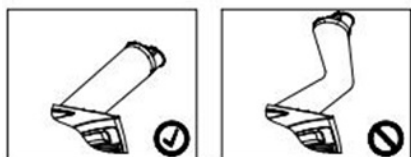
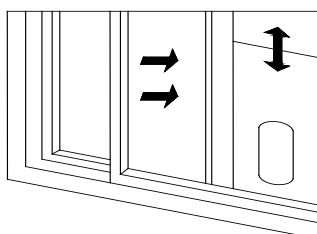
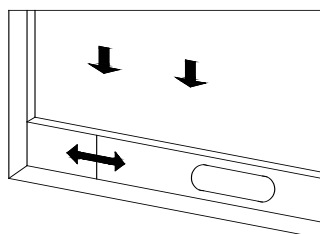

2. Fix the fishtail adaptor into the opening on the slide bar
3. Fix the exhaust connector on the opposite end of the exhaust hose to the exhaust outlet on the rear of the air conditioner.

NOTES:

- The window kit is only designed to be installed with sliding or sash windows or doors. The window kit is not designed to be used with any other style of windows.
- The fishtail adaptor can be used without the slide bar with most windows/doors.
- When using the air conditioner, ensure that the opening left around the fishtail is as small as possible, as the cooling will be less efficient.
- The best form of installation is through a wall duct. Properly venting, you expel hot air from your room while efficiently cooling it.
- If you chose to vent through the wall, you must ensure the area of the hose is not reduced as this will prevent airflow and cause damage to the unit. You should not use a fixed grill on the outside due to this. A gravity flap is suitable for this type of installation.
- Your air conditioner should be used without the vent pipe in dry mode. When using dry mode, ensure that an external water tank is used, monitored and regularly emptied before overflowing. Permanent plumbing can also be installed for dry mode, or an external uplift water pump can be set up for unattended use.

IMPORTANT SAFEGUARDS

- Please read all safety instructions in this manual.
- The length of the soft hose extends from approximately 30 cm to 180 cm. If the hose is extended above this length, the unit may malfunction, which can invalidate the warranty.
- The outlet vent must be well-ventilated and not obstructed, as this will cause the unit to overheat.
- Keep the hose as straight and short as possible and avoid bending or angling the air hose by more than 30 degrees to maintain the unit's performance. Excessive bends in the hose may prevent the unit from expelling hot air, leading to internal damage and invalidating the warranty.
- To avoid bending the hose, the unit can be raised using a stable, flat structure.
- Failure to follow any of the set-up and installation instructions will result in an invalidated warranty.

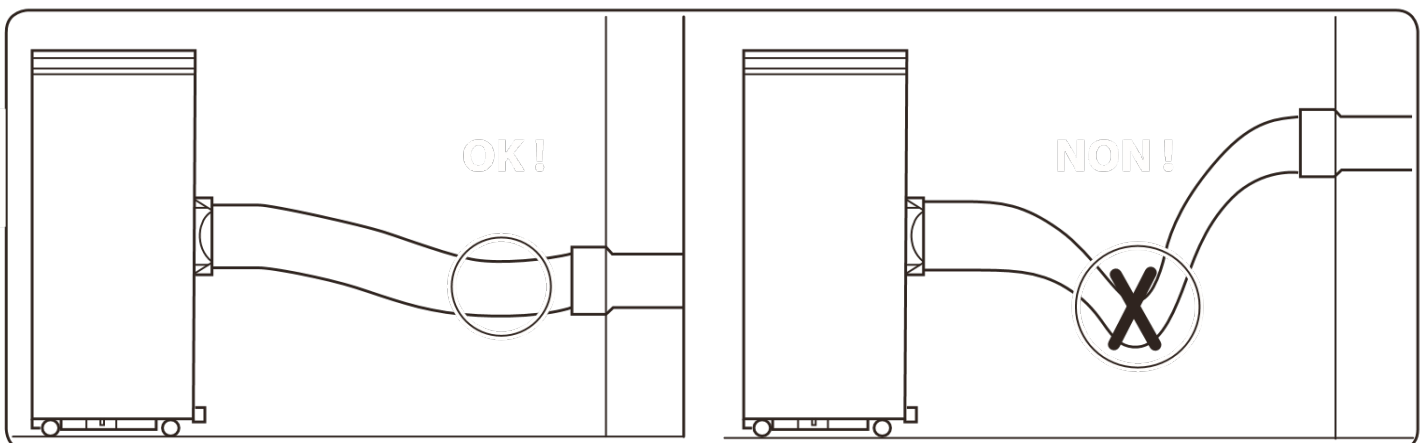

OPERATION

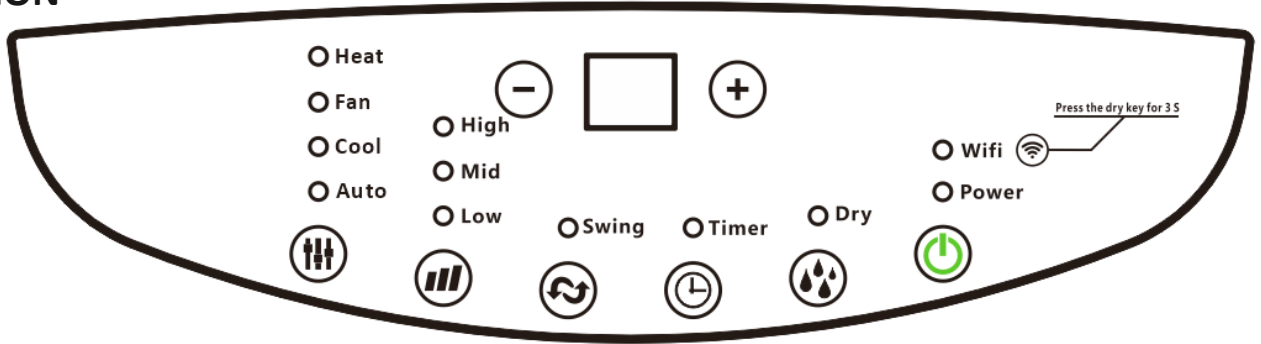

	Press the POWER button to turn the unit ON or OFF.
	<p>Press the MODE button to cycle between the 3 modes, and the indicator for the selected mode will be illuminated.</p> <p>COOL: The room is cooled with the cold air expelled through the front air outlet while hot air is expelled through the vent pipe. The desired room temperature can be set between 16 and 32 degrees using the + and – buttons, and the fan speed can be changed using the SPEED button.</p> <p>HEAT: The room is heated with the hot air expelled through the front air outlet while cold air is expelled through the vent pipe. The desired room temperature can be set between 16 and 32 degrees using the + and – buttons, and the fan speed can be changed using the SPEED button.</p> <p>FAN: The fan speed can be changed by pressing the SPEED button.</p> <p>AUTO: An intelligent cooling mode where the fan speed is automatically adjusted based on the amount of cooling required. Attempts to change the fan speed will move the unit into COOL mode.</p>
	Repeatedly press the SPEED button to cycle through the three fan speeds. Each time the SPEED button is pressed, the indicator will change to show the currently selected speed. The fan speed can be altered between Low, Med and High. The fan speed cannot be changed in DRY mode.
	<p>The timer functions cannot be combined or repeated.</p> <p>POWER ON TIMER Press the TIMER button to set the power-on timer with the appliance on standby. Use the + and - buttons to adjust the timer's duration (1 to 24 hours). The Timer indicator will turn on, and the unit will start after the selected number of hours.</p> <p>POWER OFF TIMER Press the TIMER button to set the power-off timer so the appliance runs with the desired settings. Use the + and - buttons to adjust the timer's duration (1 to 24 hours). The timer indicator will illuminate, and the unit will stop after a selected number of hours.</p>
	They are used to adjust the temperature in COOL and HEAT modes and to set the TIMER duration. The buttons are not used in FAN or DRY modes. Press both buttons together to change between displaying Celsius and Fahrenheit temperatures.
	<p>DRY (DEHUMIDIFY) The unit should be operated without the vent hose and with the unit set up for continuous drainage to remove moisture from the air. The unit will operate at low fan speed. This mode will not work as well as a traditional dehumidifier where dehumidifying is its sole purpose.</p>
	Press and hold the DRY button to turn on the WIFI function or to change between WIFI connection methods. See the WIFI section for more information.
	Press this button to enable the swing function. When the SWING button is pressed again, the louvres will stop in their current position. Do not attempt to adjust the angle of the blades manually.

REMOTE CONTROL

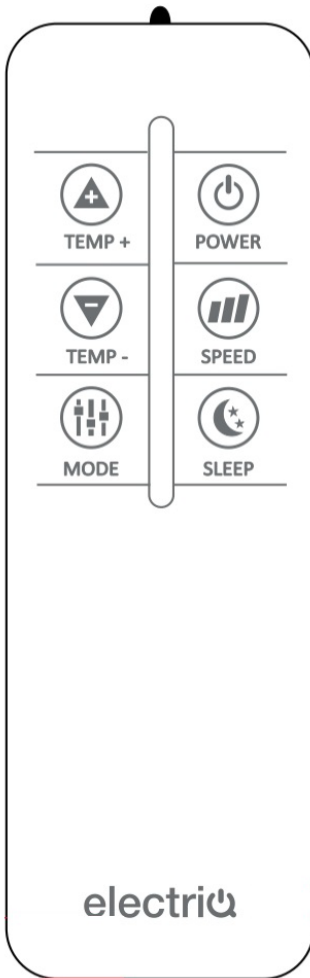

POWER	Press to turn the unit on or off.
TEMP -	Press to decrease the desired temperature or timer duration.
TEMP +	Press to increase the desired temperature or timer duration.
SPEED	Press to change between the three fan speeds.
SLEEP	Press the sleep button to enter sleep mode.
MODE	Press to change between Auto, Cool, Heat and Fan modes.

NOTE: The design of the remote may vary from the diagram due to continuous product improvement.

MULTI PROTECTIVE FUNCTIONS

FROST PROTECTION

In COOL, DRY or AUTO modes, if the temperature of the exhaust is too low, the machine will automatically stop operating until the temperature has risen.

OVERFLOW PROTECTION

When the water in the internal water tank exceeds the warning level, the machine will stop operating and sound an alarm with the LCD showing "E4". To resume operation, empty the internal water tank. After emptying the water, the machine will automatically return to its original state.

AUTO-DEFROST

The machine has an automatic defrosting function. If the internal coils' temperature drops too low during operation, the unit will enter auto defrost, and the heating symbol will flash on the control panel.

AUTOMATIC THERMAL PROTECTION

To protect the machine's service life, the machine has automatic thermal protection. If the temperature within the unit is outside of the specified range, the compressor and the lower motor will stop operation. After the machine's temperature recovers, the appliance will automatically return to regular operation.

COMPRESSOR PROTECTION

There is a 3-minute delay start protection function to prevent damage to the compressor.

EMPTYING THE INTERNAL WATER TANK

MANUAL DRAINAGE:

When the internal water tank is full, the unit will stop working. Shut off the unit and unplug it. Avoid moving the model abruptly, as this may cause the water in the internal tank to spill out. Place a tray in a drainage area under the lower water plug or the unit. Unscrew the drain plug cap and remove the rubber stopper - water will drain from the internal tank. Put the rubber stopper back and screw the drain plug cap back into place.

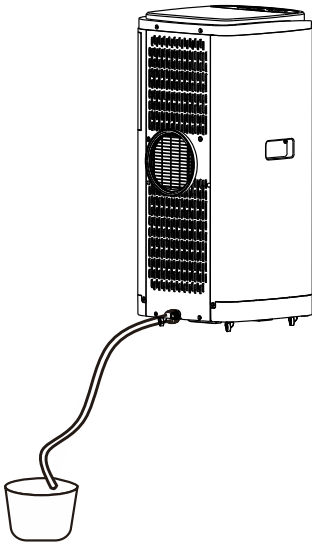
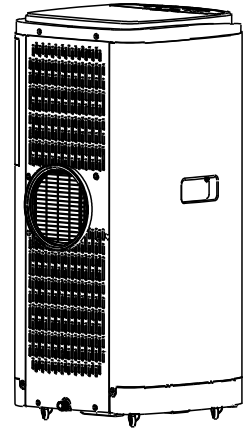

CONTINUOUS DRAINAGE:

Unscrew the drain plug cap and remove the rubber stopper. Connect a water pipe to the upper water outlet. You can plumb this pipe into your current plumbing system, lead it outside, use gravity fall, or use a water pump.

NOTE:

- This model has a self-evaporative function, which reduces the need to empty the water tank. If the unit is vented correctly, most water is reused to cool the condenser coils, and any excess is evaporated. Please do not use continuous drainage if you intend to use the self-evaporating facility.
- When using the unit in heating mode, it is advisable to use continuous drainage.

WIFI SMART CONTROL

BEFORE YOU START

- Ensure your router provides a standard 2.4 GHz connection.
- If your router is dual-band, ensure both networks have different network names (SSID). The provider of your router / Internet service provider will be able to provide advice specific to your router.
- Place the air conditioner as close as possible to the router during setup.
- Once the app has been installed on your phone, turn off the data connection and ensure your phone is connected to your router via WIFI.

DOWNLOAD THE APP TO YOUR PHONE

Download the "TUYA SMART" app from your chosen app store using the QR codes below or by searching for the app in your chosen store.



Android



IOS

CONNECTION METHODS AVAILABLE FOR SETUP

The air conditioner has two setup modes: EZ (Quick Connection) and AP (Access Point). The quick connection is a fast and simple way to set the unit up. The AP connection uses a direct local WIFI connection between your phone and the air conditioner to upload the network details.

Before starting the setup, with the air conditioner plugged in but turned off, press and hold the DRY button for 3 seconds (until you hear a bleep) to enter the WIFI connection mode.

Please ensure your device is in the correct WIFI connection mode for the connection type you are attempting; the flashing of the WIFI light on your air conditioner will indicate this.

Connection Type	Frequency of Flashes
EZ (Quick Connection)	Flashes twice per second
AP (Access Point)	Flashes once per second

CHANGING BETWEEN CONNECTION TYPES

To change the unit between the two WIFI connection modes, hold the DRY button for 3 seconds.

REGISTER THE APP

1. Press on the Sign Up button at the bottom of the screen.

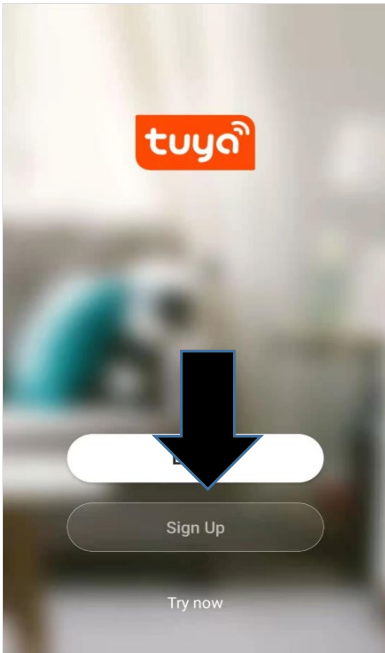

2. Read the Privacy policy and press the Agree Button.

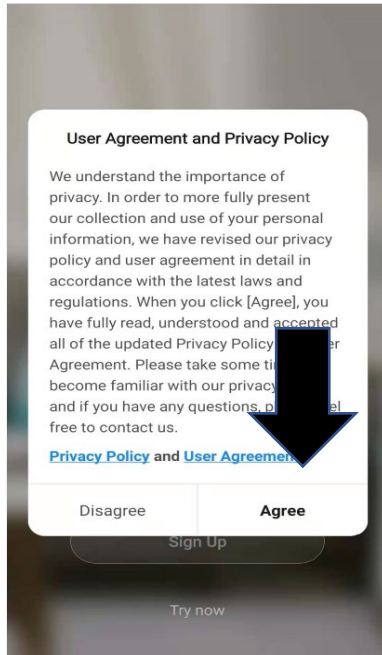

3. Enter your email address or phone number and press continue to register.

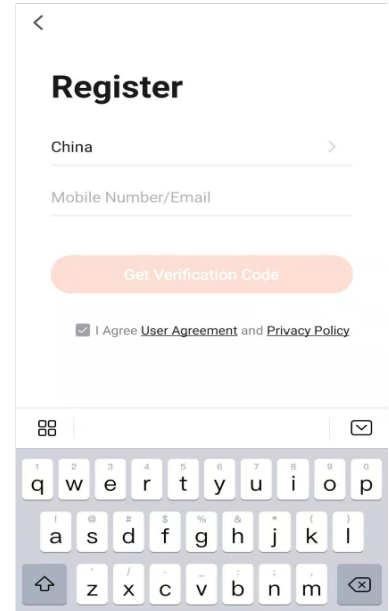

4. A verification code will be sent by the method selected in step 3. Enter the code into the app.

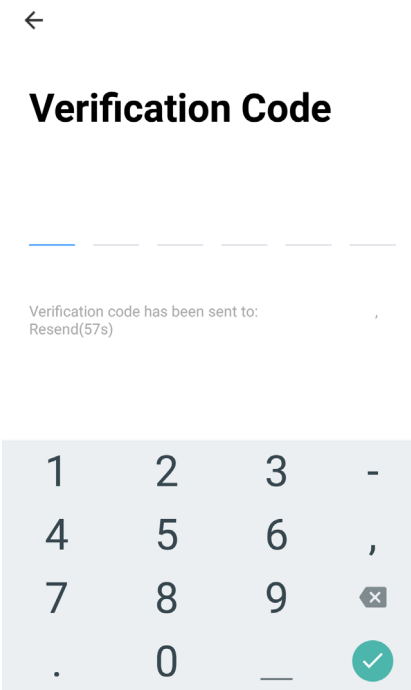

5. Type in the password you would like to create. This needs to be 6-20 characters, with letters and numbers.

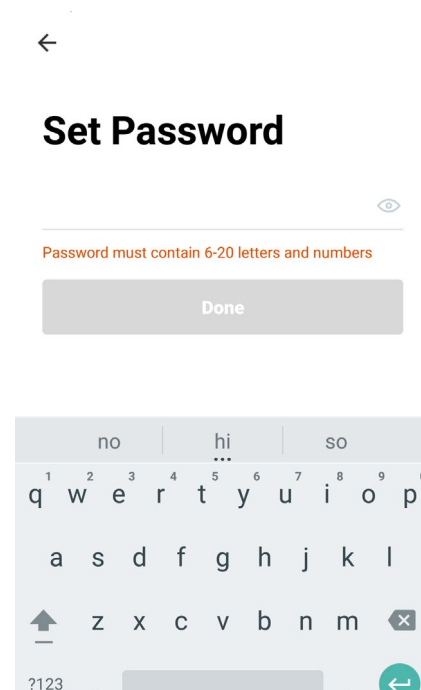

6. The app is now registered. It will automatically log you in following registration.

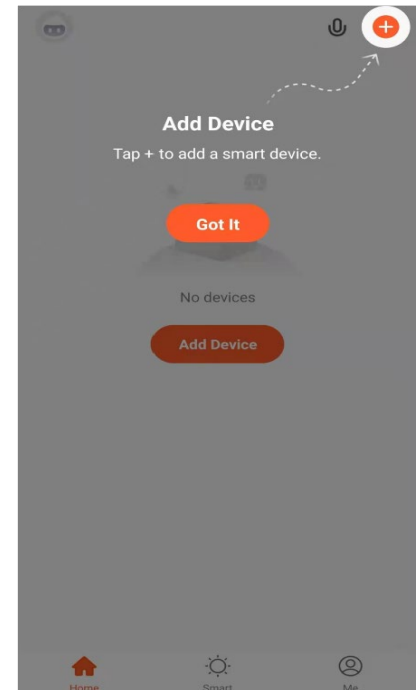

CONNECTING USING EZ (QUICK CONNECTION) MODE

Before initiating the connection, ensure the unit is in standby mode, with the WIFI light flashing twice per second. If not, follow the instructions to change the connection mode. Also, ensure your phone is connected to the WIFI network. (We advise turning mobile data off during setup)

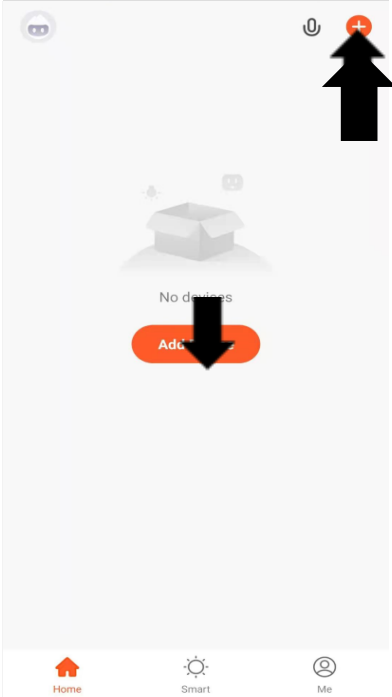
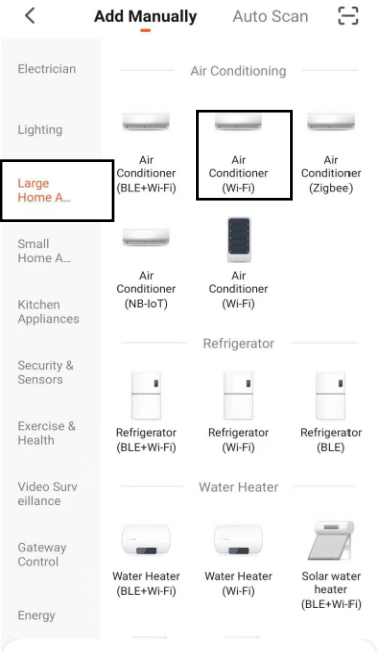
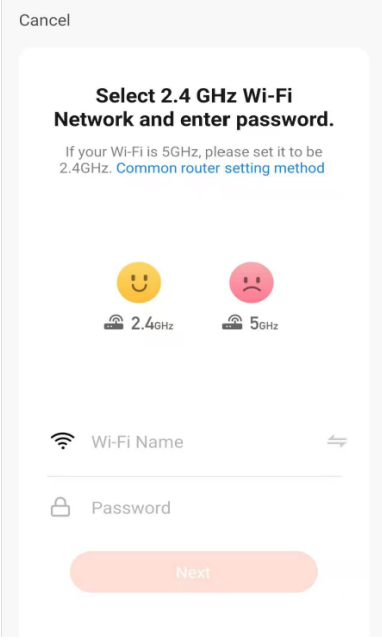
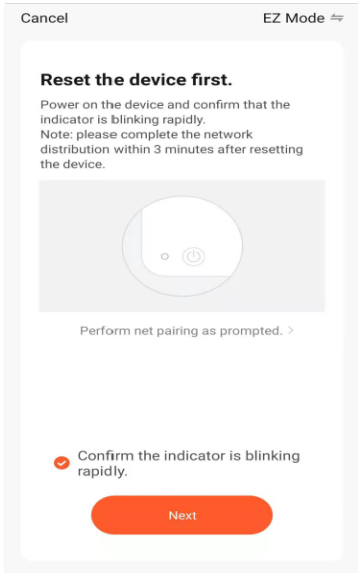
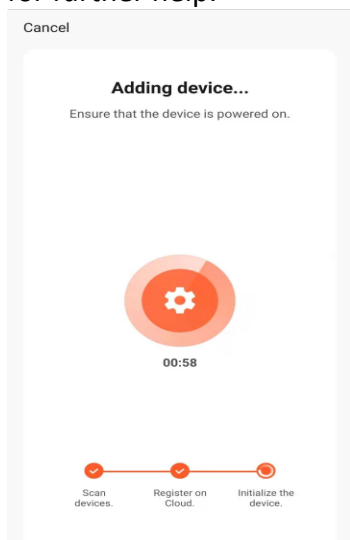
<p>1. Open the app and press “+” to add device</p> 	<p>2. Select the type of device as “Air Conditioner (WIFI)” within the Large Home Appliance tab.</p> 	<p>3. Select your network, enter your WIFI password and press Next.</p> 
<p>4. Ensure the WIFI light on the air conditioner is flashing twice per second then press on the orange button at the bottom of the screen to confirm</p> 	<p>5. This will then transfer the settings to the air conditioner. Wait for this to complete. If this fails, retry. If still unsuccessful please review the troubleshooting section for further help.</p> 	

CONNECTING USING AP MODE (ALTERNATIVE METHOD)

Before initiating the connection, ensure the unit is in standby mode, with the WIFI light flashing once per second. If not, follow the instructions for changing the WIFI connection mode. Also, ensure your phone is connected to the WIFI network. (We advise turning mobile data off during setup)

1. Open the app and press “+” to add device

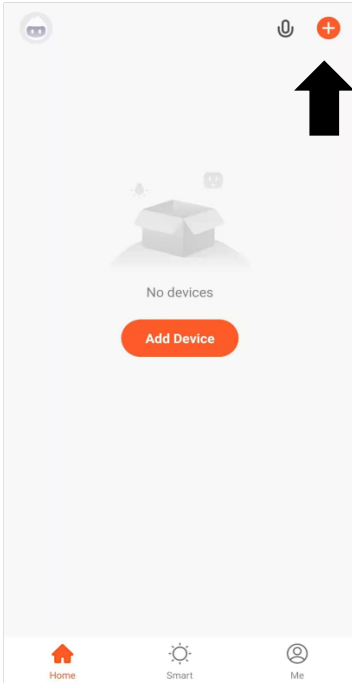

2. Select the type of device as “Air Conditioner (WIFI)” within the Large Home Appliance tab.

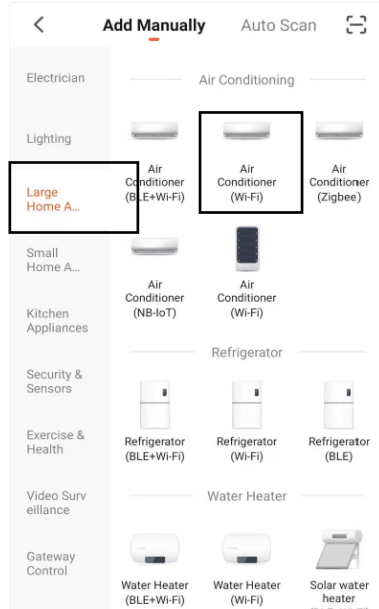

3. Select your network, enter your WIFI password and press Next.

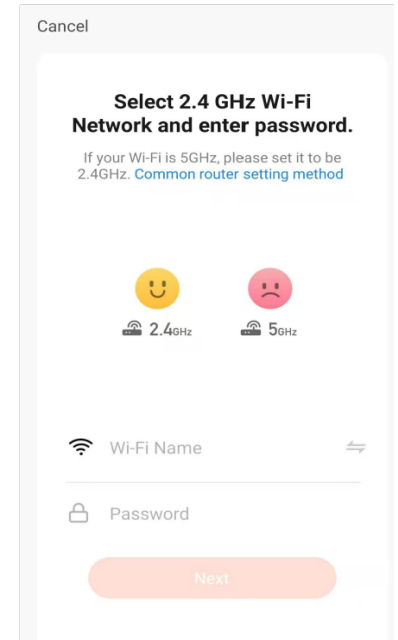

4. Ensure the WIFI light on the air conditioner is slowly flashing (once per three seconds), then select AP Mode in the top right corner before pressing on the orange button at the bottom of the screen to confirm

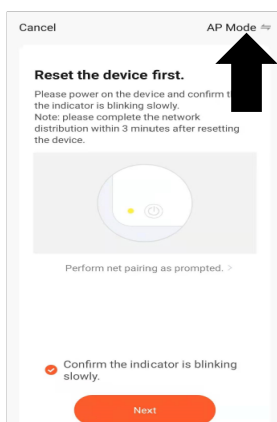

5. Go to network settings in your phone and connect to the “SmartLife xxx” connection. then press on the orange button at the bottom of the screen to confirm

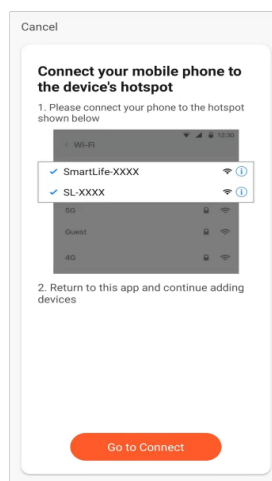

6. Go to network settings in your phone and connect to the “SmartLife xxx” connection. There is no password to enter. Then return back to the app to complete setup.

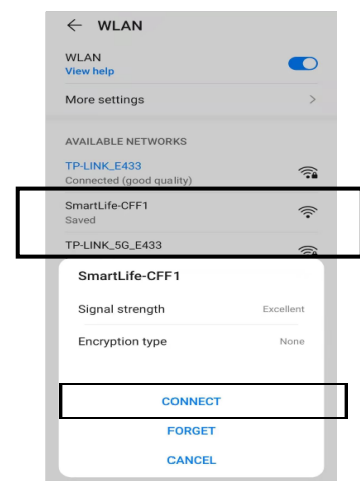

This will then transfer the settings to the air conditioner. Once the connection process has completed, go back to the network settings on your phone to ensure your phone has reconnected to your WIFI router.

CONTROLLING YOUR DEVICE THROUGH THE APP

THE HOME SCREEN

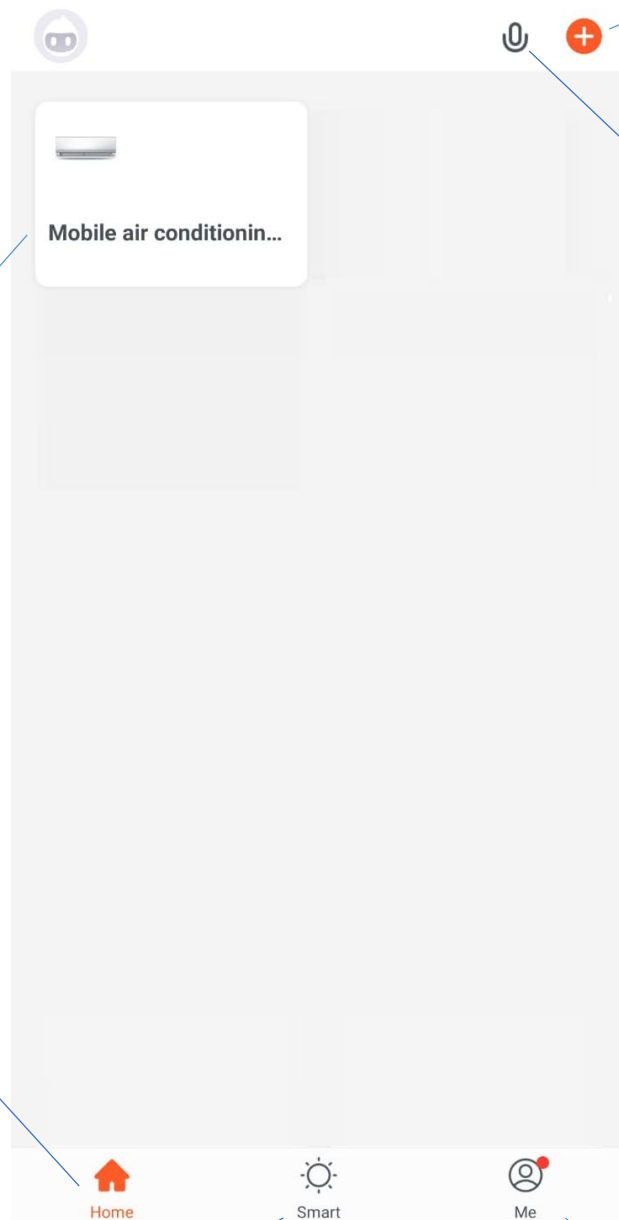

Add Device: Add a device to the app, and go through the setup process.

Your Device: Press to enter the device screen.

Voice Control: Use to give verbal instructions to the app.

Home: Return to this screen when within the Smart or profile tabs.

Smart Scene: Allows you to program intelligent behaviour based on the internal and external environment

Profile: Provides the option for changing settings, and adding devices using a QR code provided by a friend.

Each device has its entry on the home screen to allow the user to either quickly turn the unit on or off or to enter the device screen to make other changes.

DEVICE SCREEN

The device screen is the main control screen for the air conditioner, providing access to the controls to amend the functions and settings.

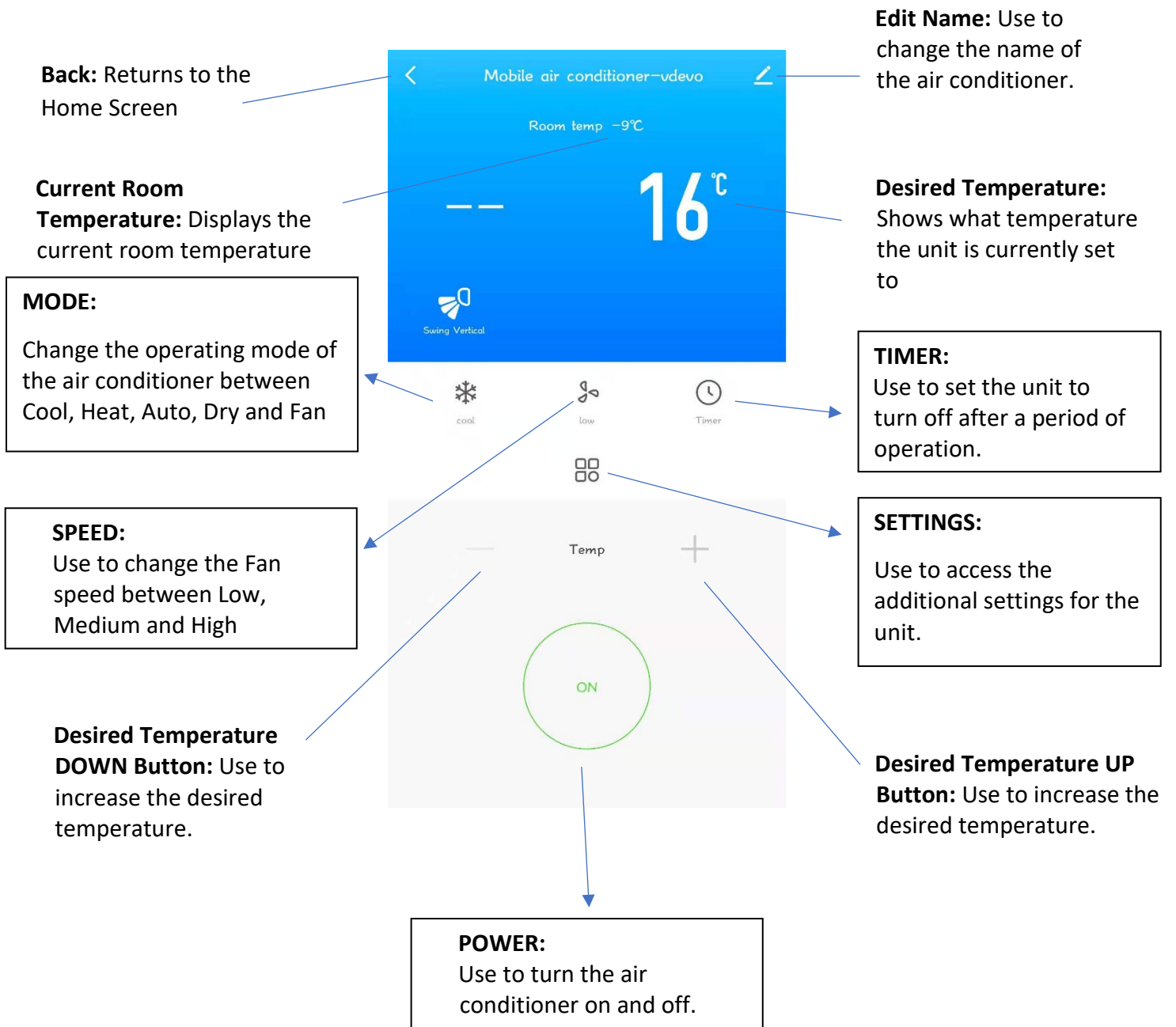

Due to the continuous development of the app, the layout and available features may be subject to change.

CREATING ROOMS

1. ON THE HOME SCREEN
Press on Home Management button

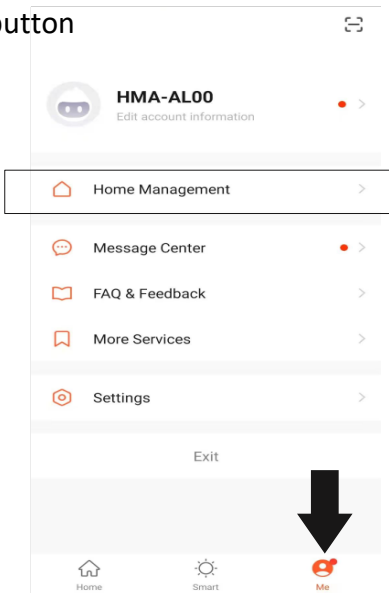

2. Type in a name for your home,
3. Press the location button to select the location of your home. (See SETTING YOUR LOCATION below)
4. New rooms can be added by pressing the ADD ANOTHER ROOM option at the bottom. (See ADD ANOTHER ROOM below)
5. Untick any rooms that are not required on the app.
6. Press DONE in the top right corner

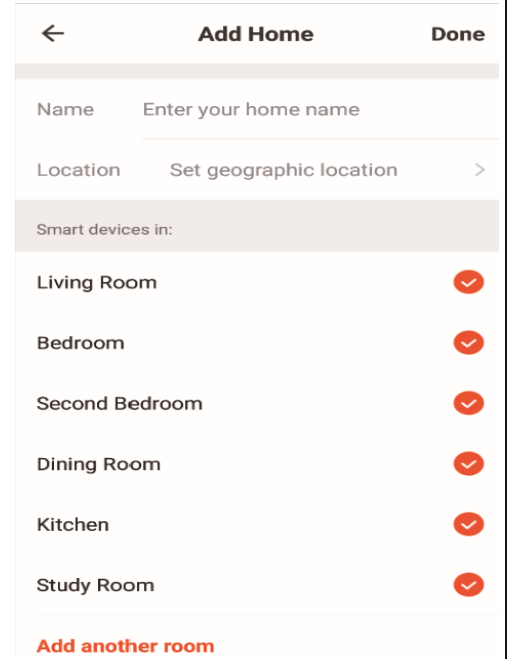

SETTING YOUR LOCATION

Use your finger to move the orange HOME symbol.

When the symbol is in the approximate location of your home, press the confirm button in the top right corner.

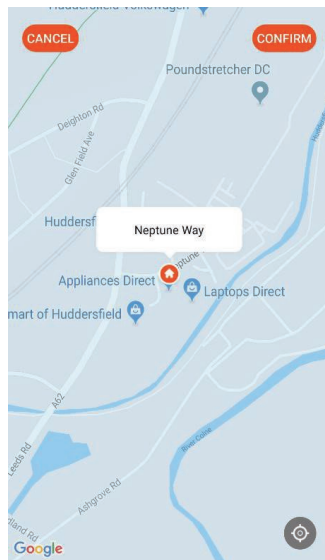

ADD ANOTHER ROOM

Type in the name of the room, and press Done in the top right corner

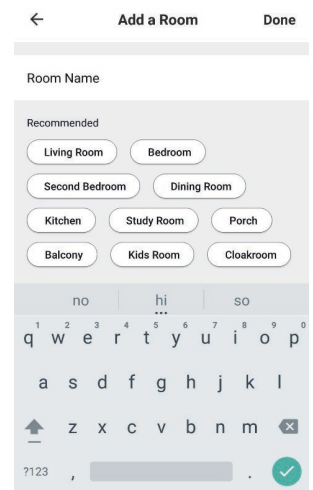

SMART SCENES

Smart Scenes is a powerful tool providing the option to customise the air conditioner operation based on conditions within the room and outside influences. This gives the user the option of specifying much more intelligent actions. These are split into two categories: Scene and Automation.

SCENE

Scene allows a one-touch button to be added to the Home screen. The button can be used to change a number of settings in one go and all the settings within the unit. Several scenes can easily be set up, allowing the user to change between several pre-set configurations easily.

Below is an example of how to set up a scene:

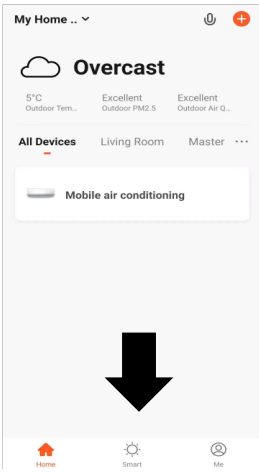
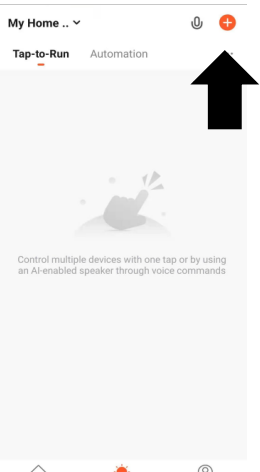
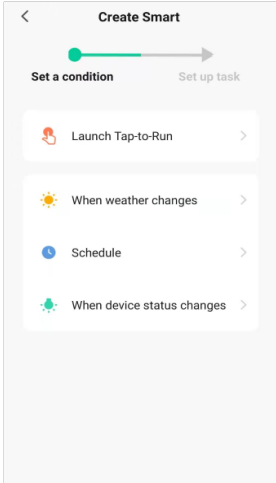
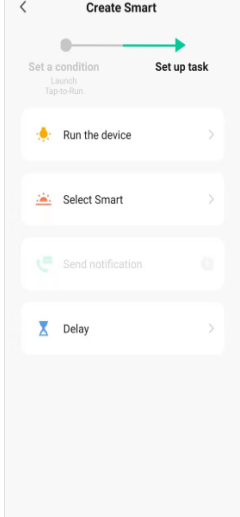
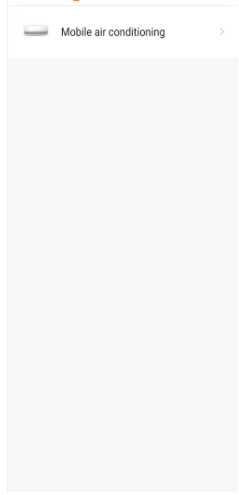
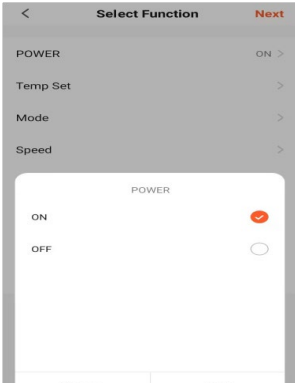
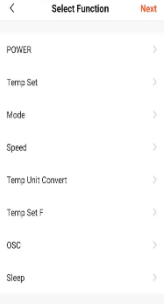
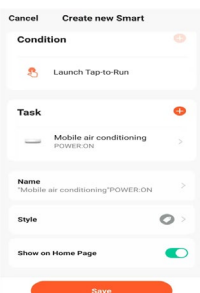
<p>1. Press on the Smart Scene tab at the bottom of the Home screen</p> 	<p>2. Press on the Plus in the top right corner to add a smart scene.</p> 	<p>3. Select the type of Scene to create.</p> 
	<p>4. Select Tap To Run, followed by the device you want to control.</p> 	<p>5. Choose the function, set the value for the function, and then press the back button in the top right corner, to return to the previous screen.</p> 
<p>6. Once all the functions required have been added, press the Next button in the top right corner to finalise and save your new Scene</p> 	<p>7. Once you have named your scene, save it, and the button will be available to activate the scene with one touch within the app.</p> 	

AUTOMATION

Automation allows an automatic action to be set up for the device. This can be triggered by the Time, indoor temperature, humidity of the room, weather conditions, and a range of other influences.

1. Press on the Smart Scene tab at the bottom of the Home screen

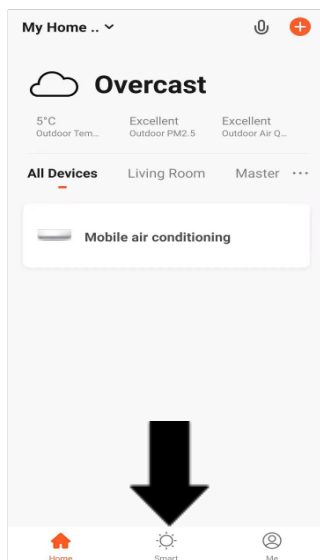

2. Press on the Plus in the top right corner to add a smart scene.

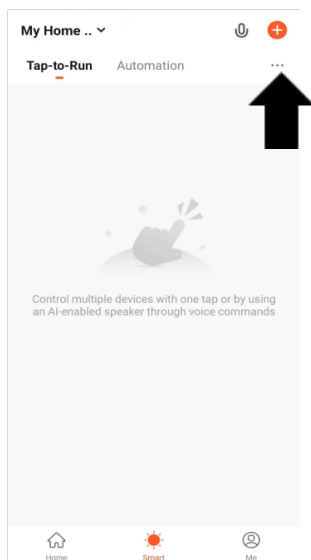

3. Select the type of automation required, such as on schedule for setting up a timed operation.

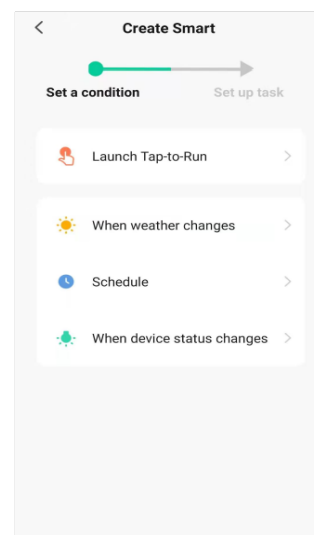

4. Select the condition when the automation should start. A number of triggers can be combined.

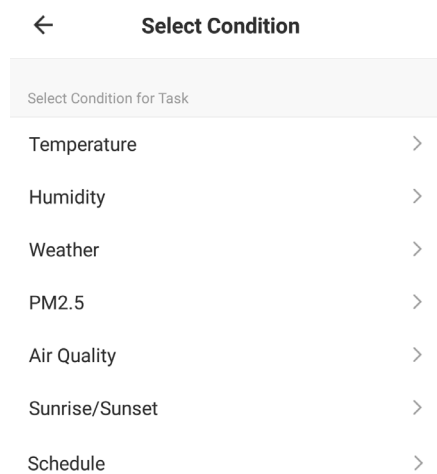

5. Chose the function, set the value for the function, and then press the back button in the top right corner, to return to the previous screen.

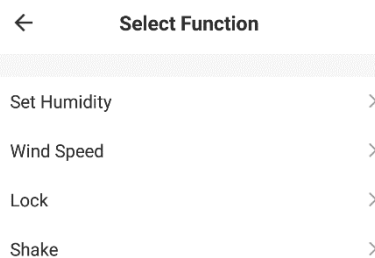

6. Once all the functions required have been added, press the Save button to finalise and save your automated action. The automation can be turned on and off as required.

PROFILE TAB

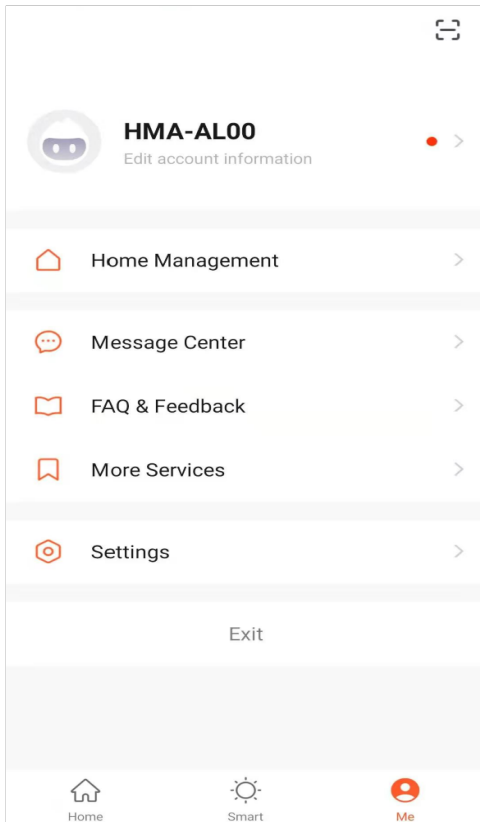

The profile tab allows you to edit both your details and use the added features of the unit.

CHANGING THE NAME OF YOUR DEVICE

In any device screen, further settings can be accessed by pressing on the three dots in the top right-hand corner. The top option within this allows you to change the name of the device to something relevant to the use of the product, such as “Living Room Air Conditioner”. Within the menu, you can also set up a pattern lock or change your password.

MESSAGE CENTRE

Shows alerts generated by the App.

MORE SERVICES

This allows the unit to be integrated with your favourite home automation hardware, such as Google Home and the Amazon Echo.

CONNECTION TROUBLESHOOTING

1. Check whether the device is powered on and is in the correct WIFI connection mode; if not, please refer to the CHANGING BETWEEN CONNECTION MODES section.
2. Ensure the WIFI password has been entered into the app correctly (Case sensitive).
3. Check that the phone is connected to the WIFI you are connecting the device to.
4. Ensure the network you are connecting it to is 2.4 GHz (5 GHz WIFI networks are not supported) and that there is a strong WIFI signal to the item.
5. If your router is dual band, ensure that the 2.4 GHz network has a different network name (SSID). Further advice on changing router settings will be available from your Internet service provider / Router manufacturer.
6. Check the settings on the router. Encryption should be WPA2-PSK, and the authorisation type should be set to AES.
7. Try using the alternative connection method. i.e., if the connection fails when attempting to connect through EZ mode, try AP mode.

CLEANING AND MAINTENANCE

PLEASE TURN OFF THE UNIT AND UNPLUG FROM THE MAINS BEFORE CLEANING OR PERFORMING ANY MAINTENANCE

CLEAN THE SURFACE

Clean the machine's surface with a wet, soft cloth. Do not use chemicals, such as benzene, alcohol, gasoline, etc; otherwise, this may cause damage to the surface and or the internal workings of the machine.

AIR FILTER CLEANING

If the filter screen is clogged with dust, the air conditioner's effectiveness is reduced. The filter screen should be cleaned once every two weeks or as often as necessary in your environment. We also recommended cleaning the filters after a period of non-use, as dust can accumulate when the appliance is stored.

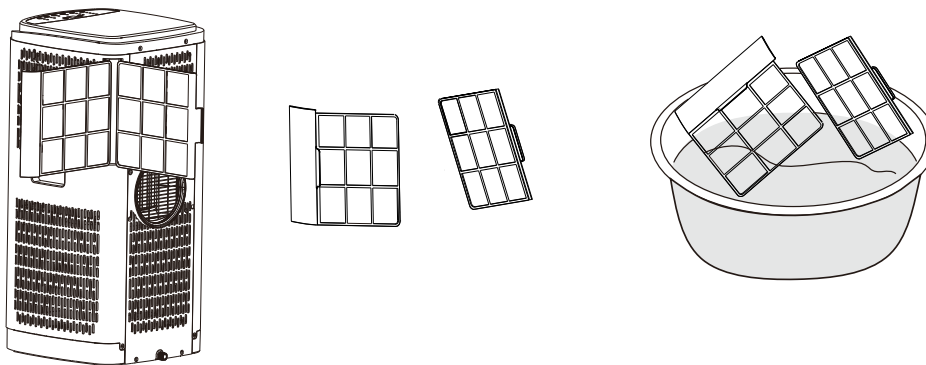

CLEAN THE UPPER FILTER SCREEN FRAME

Slide out the filter screen frames from the unit. If screws are holding the filter in place, these should be removed. The evaporator filter screen can be cleaned in warm water with neutral detergent (about 40°C /104°F). It must be rinsed clean and dried in the shade before reinstalling in the unit.

CLEAN THE LOWER FILTER SCREEN FRAME

Hold the handle of the air inlet filter screen frame and pull it outward gently to remove it. Put the filter screen into warm water with neutral detergent (about 40°C / 104 °F). It must be rinsed clean and dried in the shade before reinstalling in the unit.

END-OF-SEASON MAINTENANCE

1. Remove the rubber stopper from the drainage hole and empty the internal tank.
2. Then switch the unit to low fan mode.
3. Keep the unit in this mode for half a day - until the conduit is dried. Doing this helps to keep the inside of the unit dry and prevents mould from developing.
4. Turn off the unit and pull out the plug.
5. Replace the rubber stopper.
6. Coil the wire, bind it together, and put it into the accessories space.
7. Separate the air-exhaust pipe and store it safely.
8. Cover the unit and keep it in a dry place.
9. Take the batteries out of the remote control and store or dispose of them safely. Keep all accessories with the unit ready for next season.

TROUBLESHOOTING

Do not repair or disassemble the air conditioning. Unqualified repair will invalidate the warranty and may lead to failure, causing injuries and property damage. Only use it as directed in this user manual and only perform operations advised here.

Problems	Reasons	Solutions
The air conditioner does not work.	There is no electricity.	Turn it on after connecting it to a socket with electricity.
	The display shows "E4".	Discharge the water inside.
	The ambient temperature is too low or too high.	Only use the machine within the temperature range of 7-35°C (44-95°F).
	In cooling mode, the room temperature is lower than the desired temperature.	Change the desired temperature.
	In dry mode, the ambient temperature is low.	The ambient temperature must be above 16 °C. (60 °F).
The cooling effect is not good	There is direct sunlight.	Use curtains to reduce the direct sun heat.
	Doors or windows are open; there are a lot of people; or in cooling mode, there are other sources of heat (e.g. fridges)	Close doors and windows; increase air conditioning power
	The filter screen is dirty.	Clean or replace the filter screen.
	The air inlet or outlet is blocked.	Clear obstructions: make sure venting is correct as described in this user manual and the hose is not bent
Loud Noise	The air conditioning is not placed on a flat surface.	Put the air conditioning in a flat, hard place (to reduce noise). Correct any venting issues.
The compressor does not work.	Overheat protection starts.	Wait 3 minutes until the temperature is lowered, then restart the machine. Correct any venting issues.
The remote control does not work.	The distance between the machine and the remote control is too far.	Let the remote control get close to the air conditioner and ensure that the remote control directly faces the receiver.
	The remote control is not aligned with the receiver.	
	Batteries are dead.	Replace batteries.
Others	No refrigerant or there is minimal refrigerant.	Refer to Service Centre (check leakage, welding, vacuum pump, charge refrigerant according to nameplate)
	Anti-freezing protection	Waiting for defrosting. The function will recover automatically. No user input is needed.
	High-pressure protection	After the inside gas pressure comes down, it will function normally. No user input is needed.

If problems not listed in the table occur or recommended solutions do not work, please get in touch with the service centre.

ERROR CODES

CODE	CAUSE	SOLUTION
dH	Unit in dry mode	It's not a fault; no action is required.
E2	Room temperature sensor error	The room temperature is outside the operational range. Do not operate until the room is within the range required.
E4	Water full alarm	Empty the water tank
E5	Temperature sensor error	Check the route of the vent pipe to ensure it is not constructed.
MODE LIGHT FLASHING	Cool/dry mode: the compressor has not started, and the mode light will flash. This is normal	The unit will start operation when the protection period has finished (approx. 3 minutes)

APPENDIX



Disposal: Do not dispose of this product as unsorted municipal waste. Collection of such waste must be handled separately as special treatment is necessary. Recycling facilities are now available for all customers at which you can deposit your old electrical products. Customers will be able to take any old electrical equipment to participating civic amenity sites run by their local councils. Please remember that this equipment will be further handled during the recycling process, so please be considerate when depositing your equipment. Please contact the local council for details of your local household waste recycling centres.

electriQ UK SUPPORT

www.electriQ.co.uk/support

For your convenience, please make these simple checks before calling the service line. Call the number below if the unit still fails to operate, or complete the online form.

0330 390 3061

1. Has the unit been standing upright for at least 2 hours?
2. Is the unit plugged into the mains?
3. Is the fuse OK?
4. Switch the unit off and wait three minutes to see if the issue is resolved. Restart the unit.
5. Check if the water tank is full.

Office hours: 9 AM - 5 PM, Monday to Friday

www.electriQ.co.uk

Unit 2A, Trident Business Park,
Neptune Way, Leeds Road,
Huddersfield, HD2 1UA.

DECLARATION OF CONFORMITY

Hereby, electriQ declares that this Portable air conditioner is in compliance with Directive 2014/53/EU. The full text of the EU declaration of conformity is available at the following internet address:

<https://www.electriQ.co.uk/content/declaration-of-conformity>

TECHNICAL DATA

Model	P12HPW
Cooling capacity:	12,000 BTU
Heating Capacity	11,800 BTU
Cooling Input Power:	1300 W
Heating Input Power	1150 W
Fan	AC motor with 3 fan speeds.
Air flow volume:	420 m ³ /h
Cooling Input Current:	5.65 A
Heating Input Current:	5.0 A
Refrigerant:	R290/280g
Sound power level:	56 dB(A)
Thermostat:	16-32°C
Maximum working pressure of suction/exhaust side:	1.0/3.5 MPa
Maximum Allowable Pressure	3.5 Mpa
Power Supply:	AC 230V/50 Hz
Net Weight:	28 kg
Dimension(L*D*H):	360 x 390 x 793 mm
<p>Unit must be vented outside when in Air Cooling mode. For the purposes of EU regulation EN12102 this is a local air conditioner and produces less than 65dB(A) sound energy</p> <div style="text-align: center;">  <p>R 290</p> </div>	